

ELEKTROSCHEMA

Projektbeschreibung: Demoprojekt

Anlage: AHY10

Objekt: Demoprojekt

Kunde:

Auftragsnummer: 23-4000.17

Zeichnungsnummer: 40.8050-17

TinLine GmbH

CAD/CAE für die Elektrotechnik
Schürmattstrasse 4

CH-5643 Sins www.tinline.ch

Tel: 041/787 35 35 Fax: 041/787 35 32

Rev.	Änderung	Datum	Name	Erstellt von	TinLine
				Datum	24.11.2017
				Nächstes Blatt	2
				Anzahl Blätter	14
				Blatt	1

TINLINE_1

Inhaltsverzeichnis

Anlage	Seite	Ort	Bezeichnung 1	Bezeichnung 2	Datum	Ersteller
AHY10	1		Deckblatt		24.11.2017	Autodesk
AHY10	2		Inhaltsverzeichnis		24.11.2017	sandro
AHY10	3	H1	Einspeisung		24.11.2017	Autodesk
AHY10	4	H1	Hydraulik Antrieb		24.11.2017	Autodesk
AHY10	5	H1	SPS Hydraulik		24.11.2017	Autodesk
AHY10	6	H1	Kühlmittelpumpe		24.11.2017	Autodesk
AHY10	7	H1	Greifer		24.11.2017	Autodesk
AHY10	8	H1	SPS-Übersicht		24.11.2017	Autodesk
AHY10	9	H1	Kabelplan I		24.11.2017	Autodesk
AHY10	10	H1	Kabelplan II		24.11.2017	Autodesk
AHY10	11	H1	Kabelplan III		24.11.2017	Autodesk
AHY10	12	H1	Kabelplan IV Steckerplan		24.11.2017	Autodesk
AHY10	13		Schaltschrank		24.11.2017	Autodesk
AHY10	14		Klemmleisten		24.11.2017	Autodesk

A

A

B

B

C

C

D

D

E

E

F

F

1 2 3 4 5 6 7 8

A B C D E F

HAUPTSCHALTER

ANTRIEB

BELEUCHTUNG

GLEICHSTROM-STEUERUNG

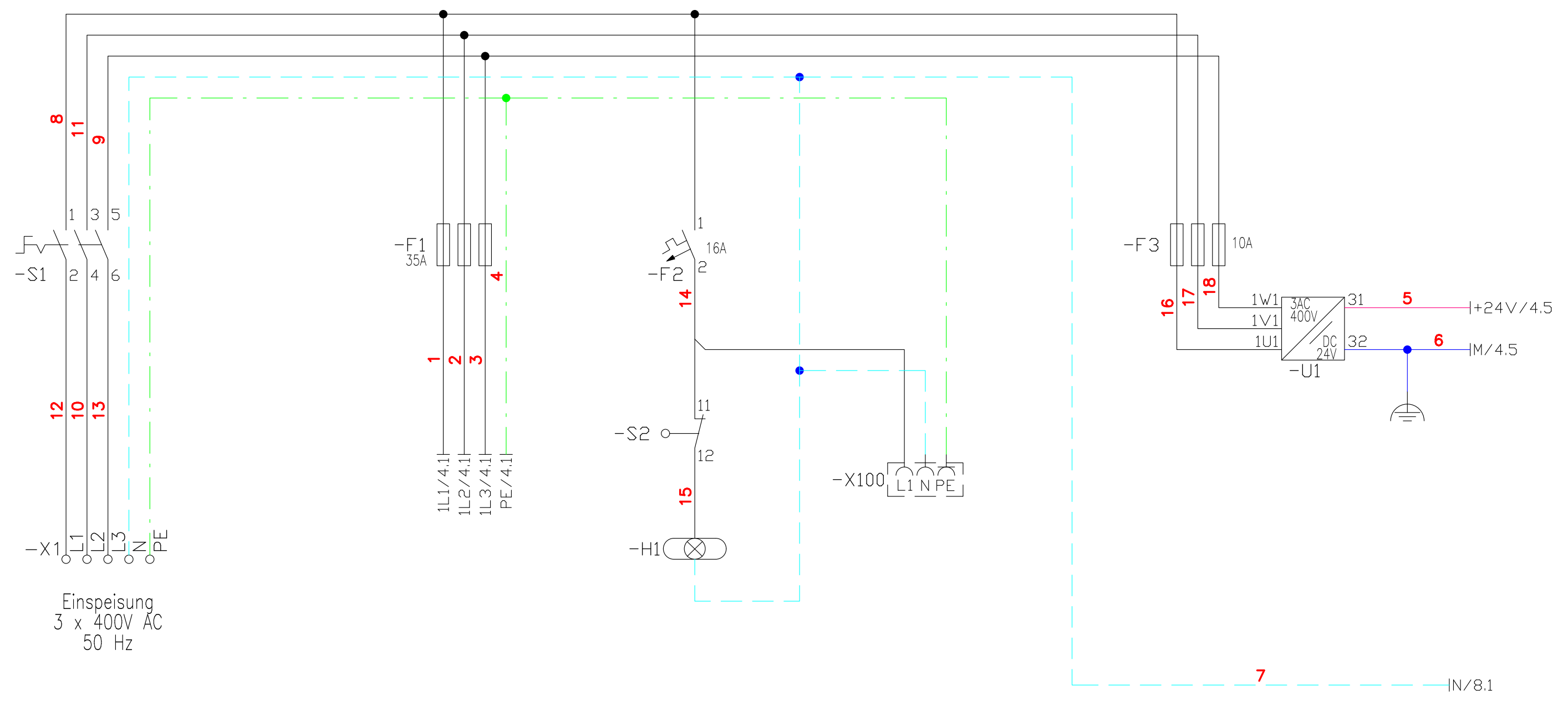

Einspeisung
3 x 400V AC
50 Hz

TinLine GmbH

Datum	24.11.2017
Bearb.	TinLine
Gepr.	
Rev.	Änderung
Datum	Name
Norm	

Demoprojekt
23-4000.17

TinLine GmbH
Schümattstrasse 4
CH - 5643 Sins

Einspeisung

Zeichnungsnummer
40.8050-17

= AHY10
+ H1
14 Bl. Blatt 3

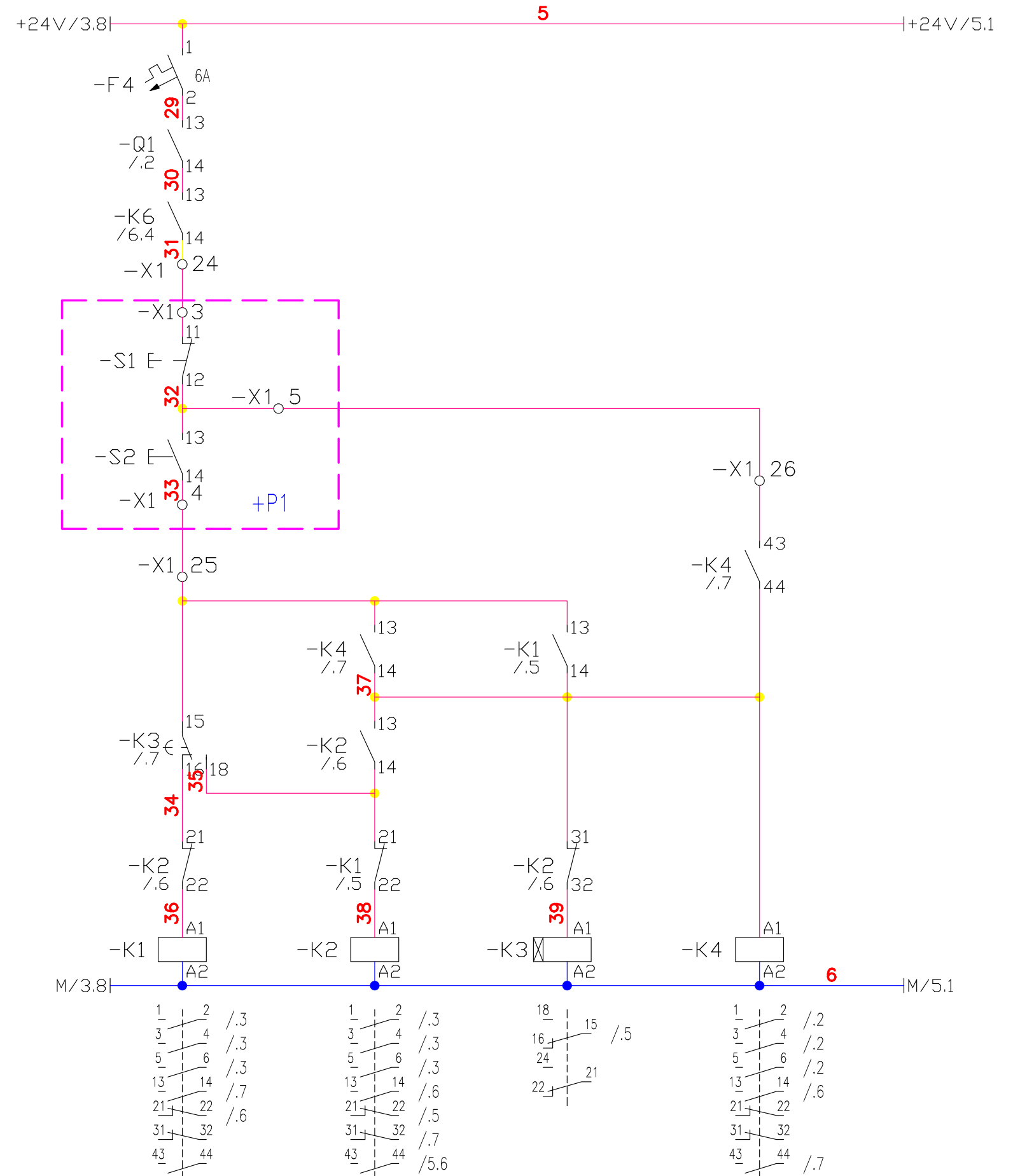
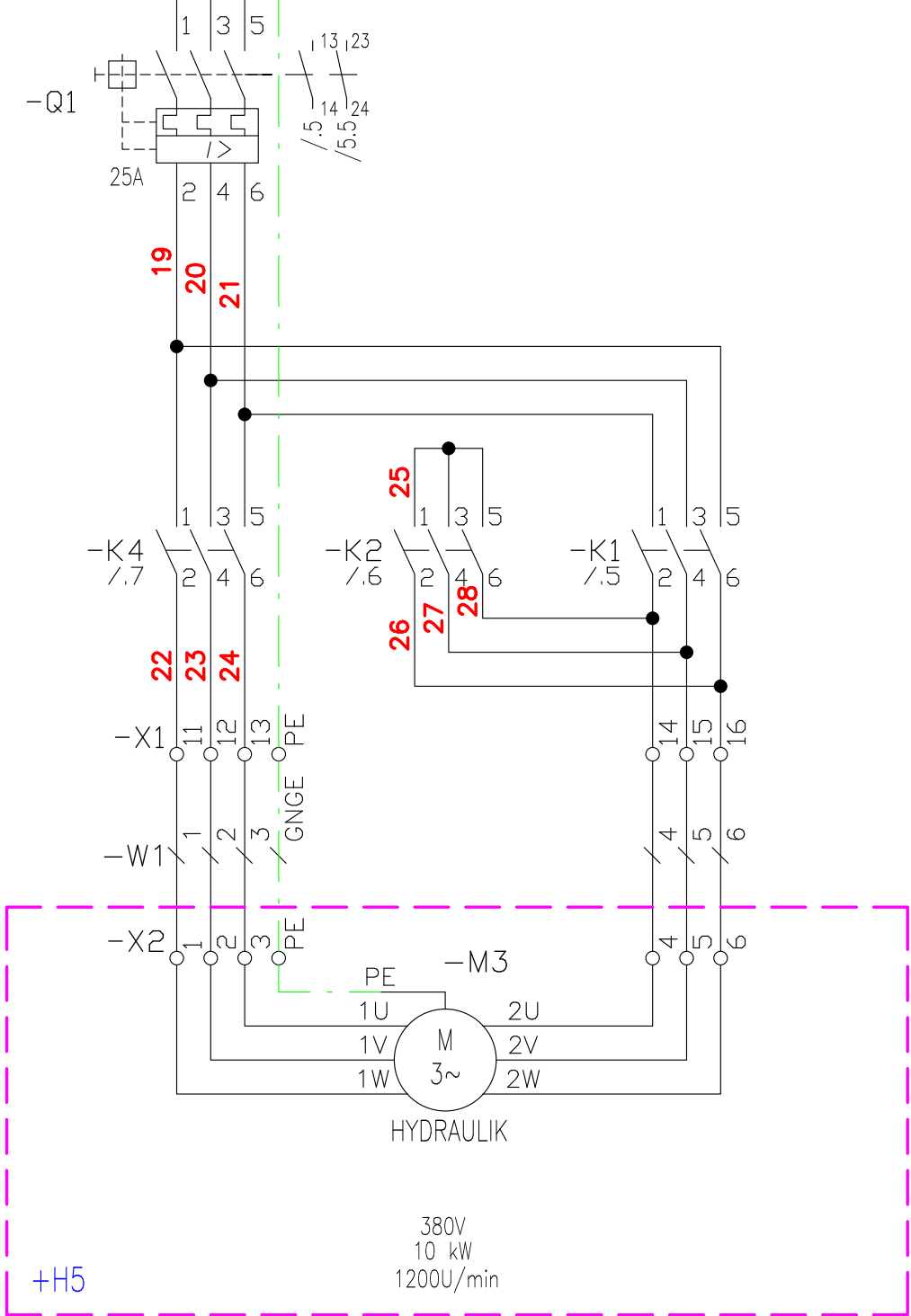
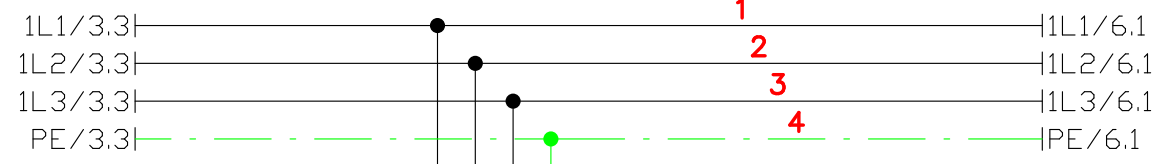

TinLine GmbH		Datum	24.11.2017	Demoprojekt	TinLine GmbH	Hydraulik Antrieb	Zeichnungsnummer	= AHY10
		Bearb.	TinLine	23-4000.17	Schüemattstrasse 4		40.8050-17	+ H1
		Gepr.			CH - 5643 Sins			14 Bl. Blatt 4
Rev.	Änderung	Datum	Name					

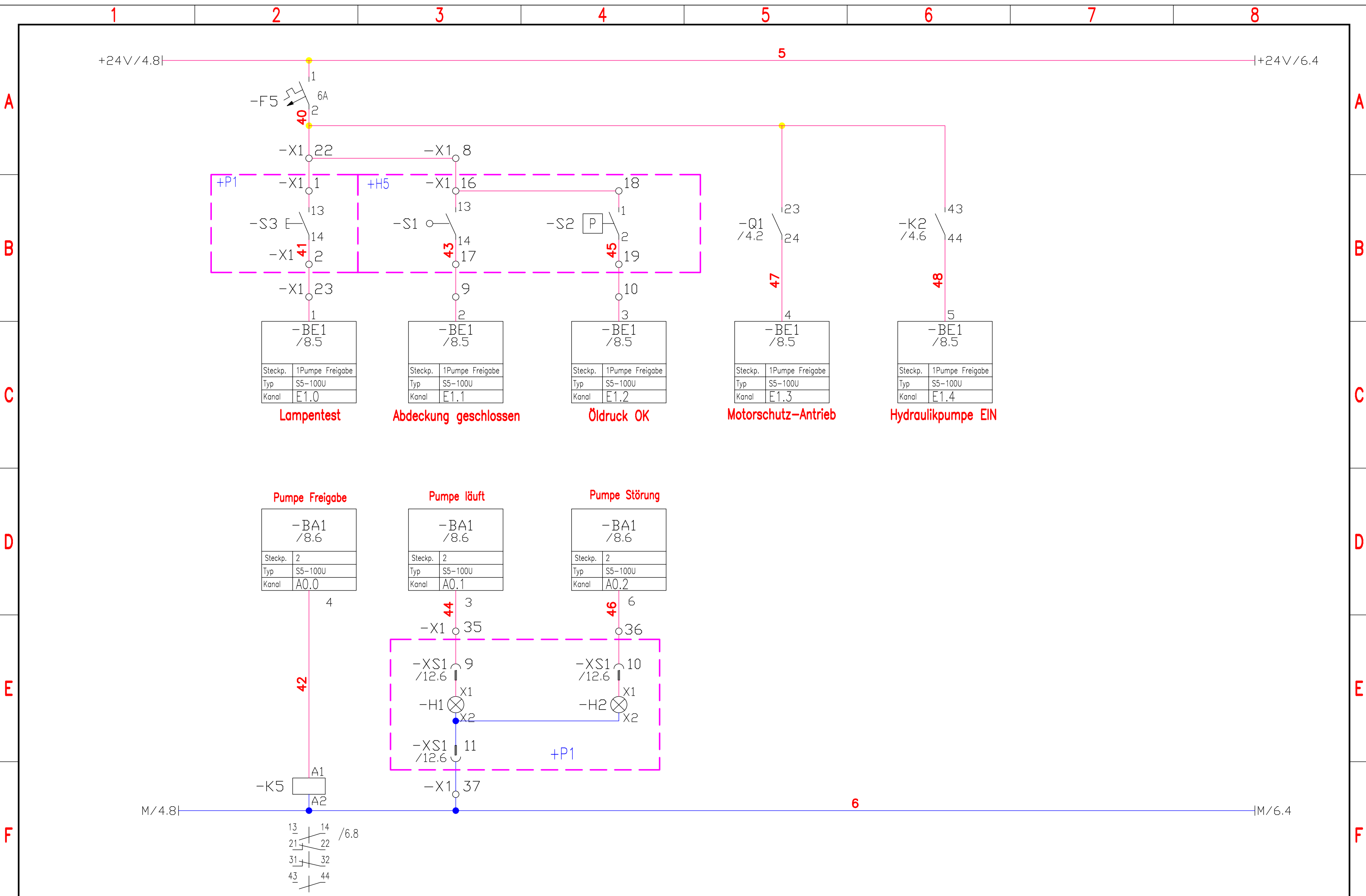

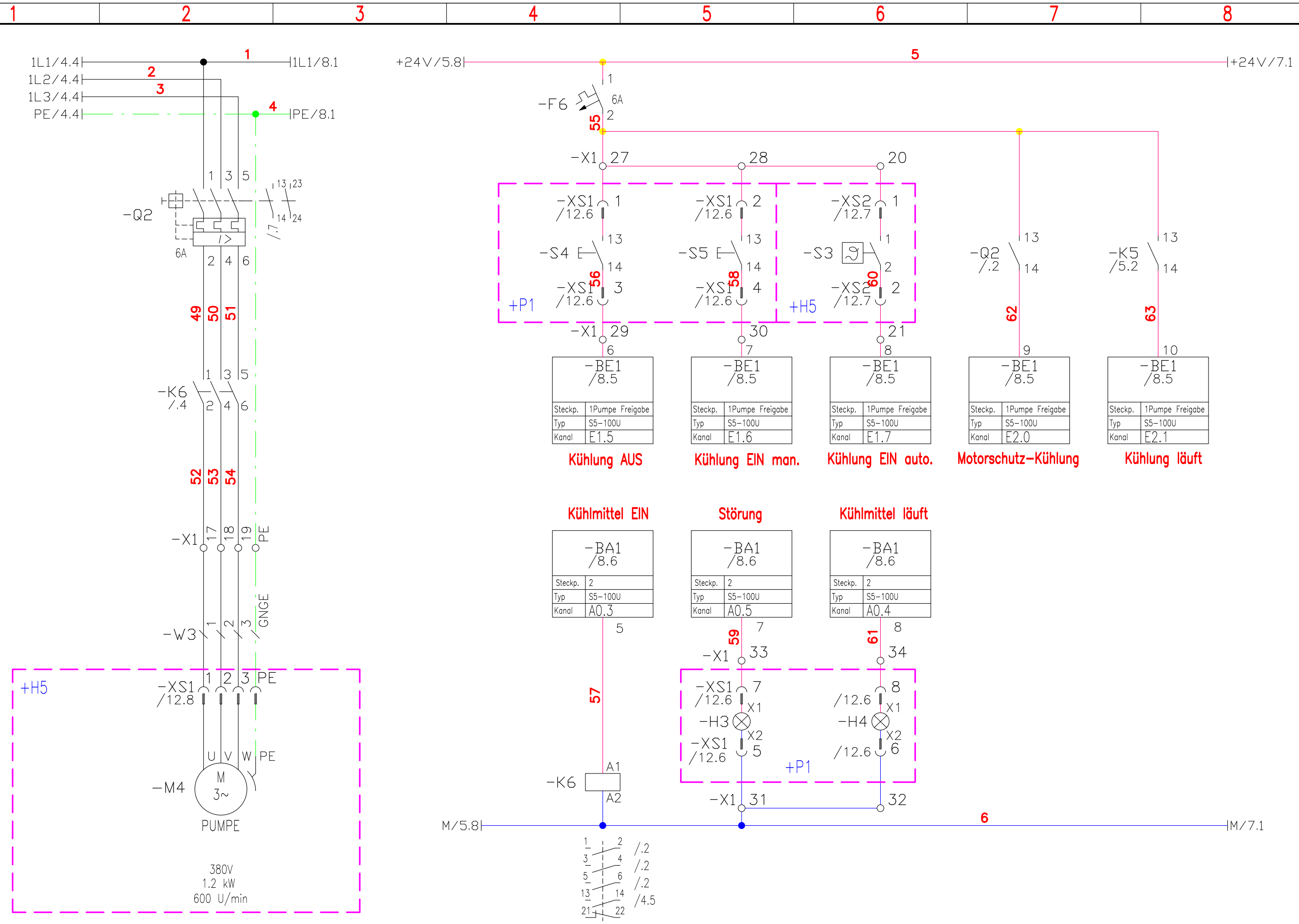

TinLine GmbH		Datum	24.11.2017	Demoprojekt	TinLine GmbH Schümmattstrasse 4 CH - 5643 Sins	Kühlmittelpumpe	Zeichnungsnummer 40.8050-17	= AHY10	
		Bearb.	TinLine					+ H1	
Rev.	Änderung	Datum	Name					23-4000.17	14 Bl.

A

B

C

D

E

F

A

B

C

D

E

F

1 2 3 4 5 6 7 8

+24V/6.8 |-----| +24V/8.1

M/6.8 |-----| M/8.1

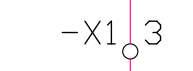
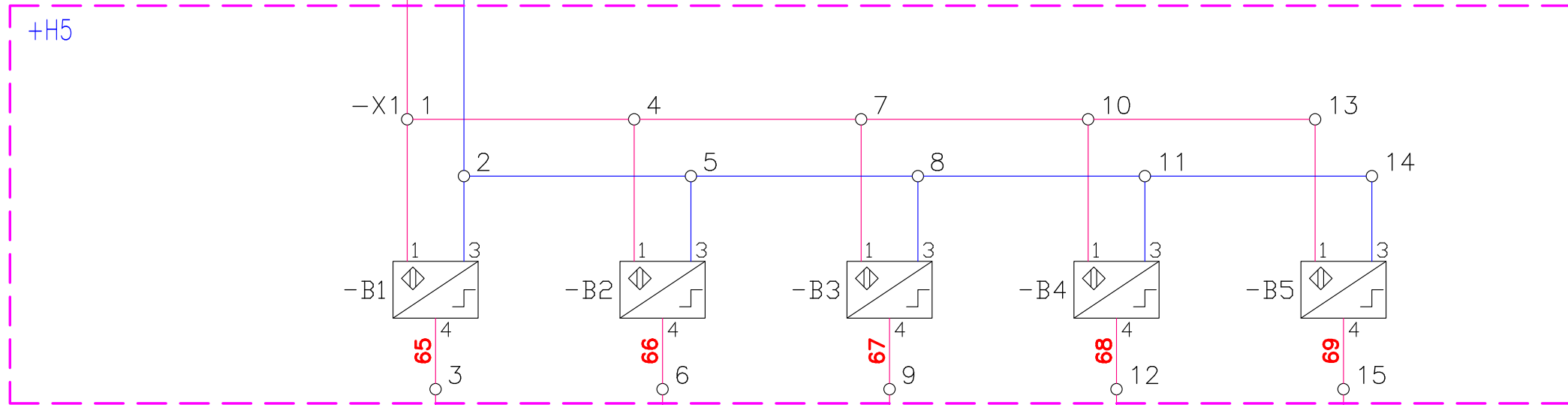
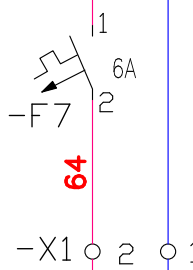

-BE1 /8.5	
Steckp.	1Pumpe Freigabe
Typ	S5-100U
Kanal	E2.2

Greifer oben

-BE1 /8.5	
Steckp.	1Pumpe Freigabe
Typ	S5-100U
Kanal	E2.3

Greifer unten

-BE1 /8.5	
Steckp.	1Pumpe Freigabe
Typ	S5-100U
Kanal	E2.4

Greifer mitte

-BE1 /8.5	
Steckp.	1Pumpe Freigabe
Typ	S5-100U
Kanal	E2.5

Greifer Gefahr

-BE1 /8.5	
Steckp.	1Pumpe Freigabe
Typ	S5-100U
Kanal	E2.6

Greifer läuft

TinLine GmbH

Datum	24.11.2017
Bearb.	TinLine
Gepr.	
Rev.	Änderung
Datum	
Name	
Norm	

Demoprojekt
23-4000.17

TinLine GmbH
Schümattstrasse 4
CH - 5643 Sins

Greifer

Zeichnungsnummer
40.8050-17

= AHY10	
+ H1	
14 Bl.	Blatt 7

1 2 3 4 5 6 7 8

EINGÄNGE AUSGÄNGE

-BZ1 -BC1 -BE1 -BA1 -BS1

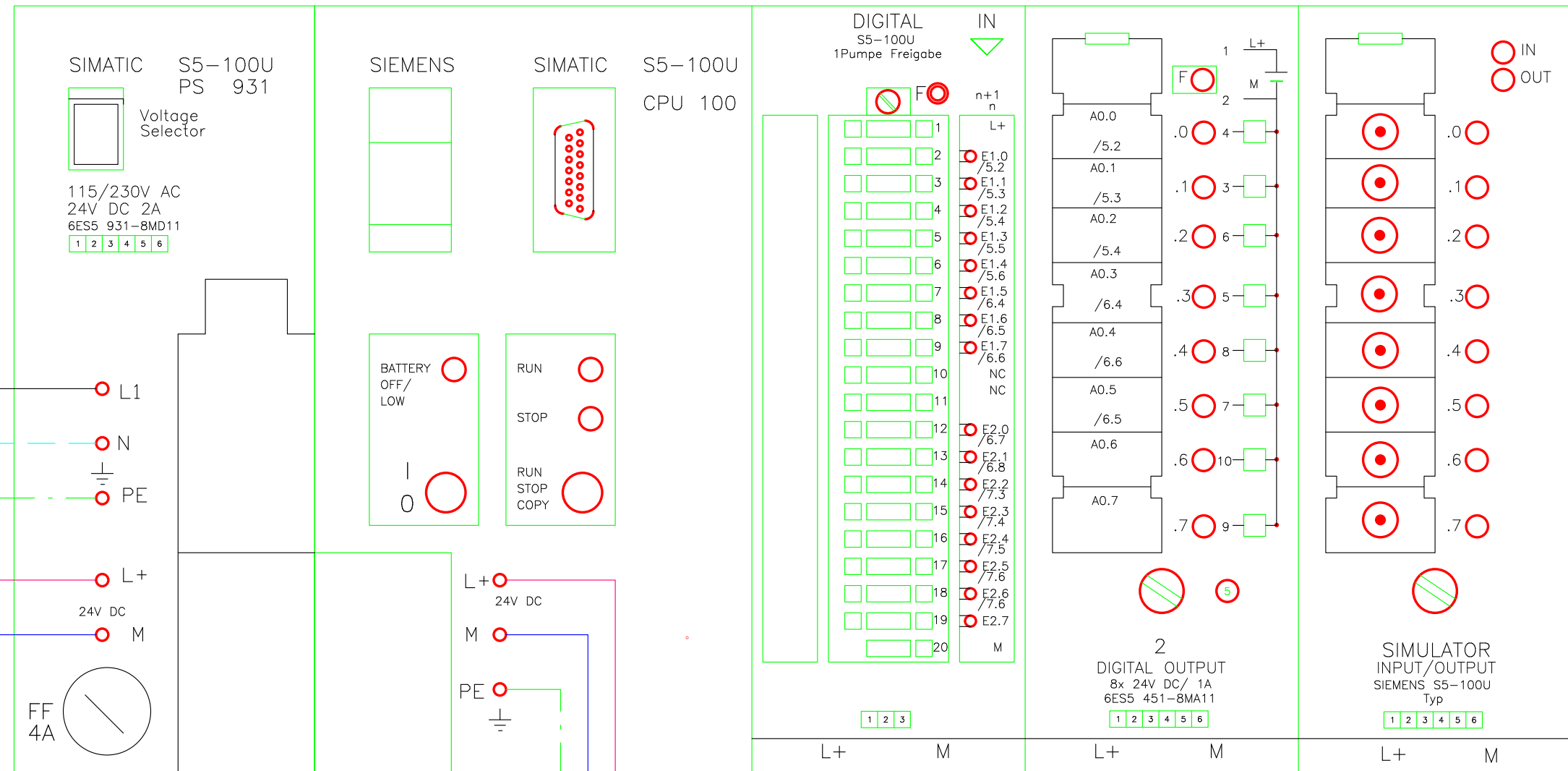

1L1/6.3| 1
 +24V/7.8| 5
 M/7.8| 6
 N/3.8| 7
 PE/6.3| 4

TinLine GmbH		Datum	24.11.2017	Demoprojekt	TinLine GmbH Schümmattstrasse 4 CH - 5643 Sins	SPS-Übersicht	Zeichnungsnummer 40.8050-17	= AHY10	
		Bearb.	TinLine					+ H1	
Rev.	Änderung	Datum	Name					23-4000.17	14 Bl.

1 2 3 4 5 6 7 8

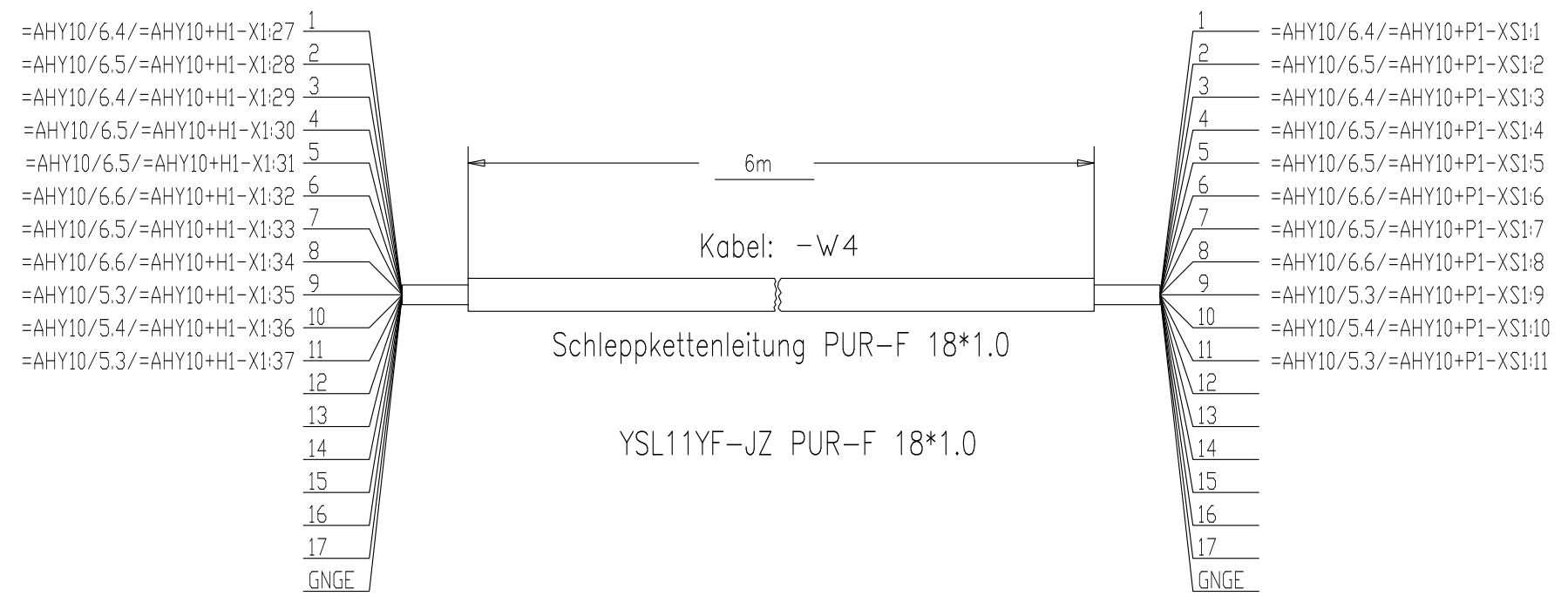
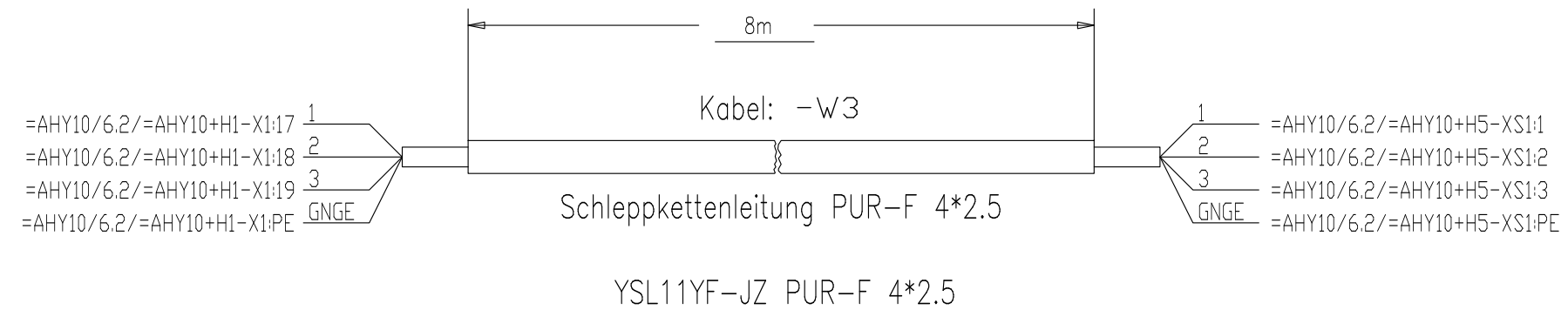
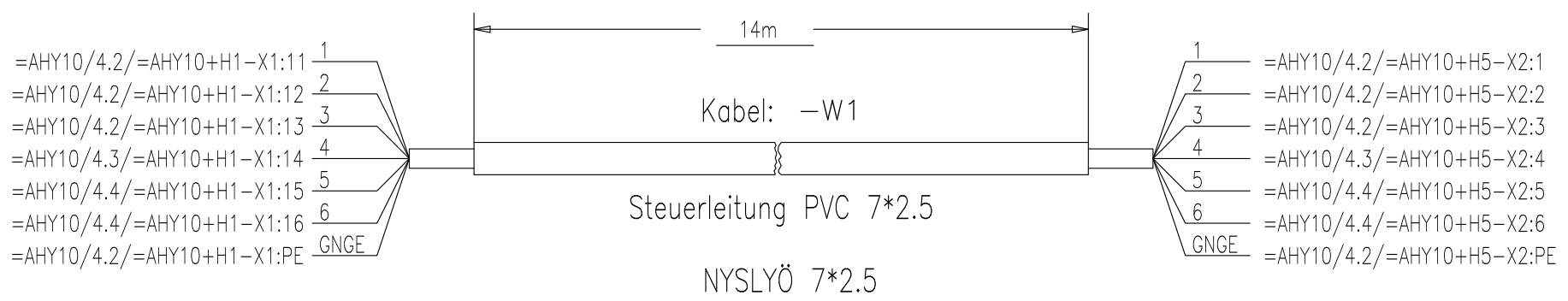

A

A

B

B

C

C

D

D

E

E

F

F

TinLine GmbH

Rev.	Änderung	Datum	Name	Datum	24.11.2017	Demoprojekt	TinLine GmbH Schümmattstrasse 4 CH - 5643 Sins	Kabelplan I	Zeichnungsnummer 40.8050-17	= AHY10 + H1
				Bearb.	TinLine					
				Gepr.						
< 8	1	2	3	4	5	23-4000.17				14 Bl. Blatt 9

< 8

1 2 3 4 5 6 7 8

10 >

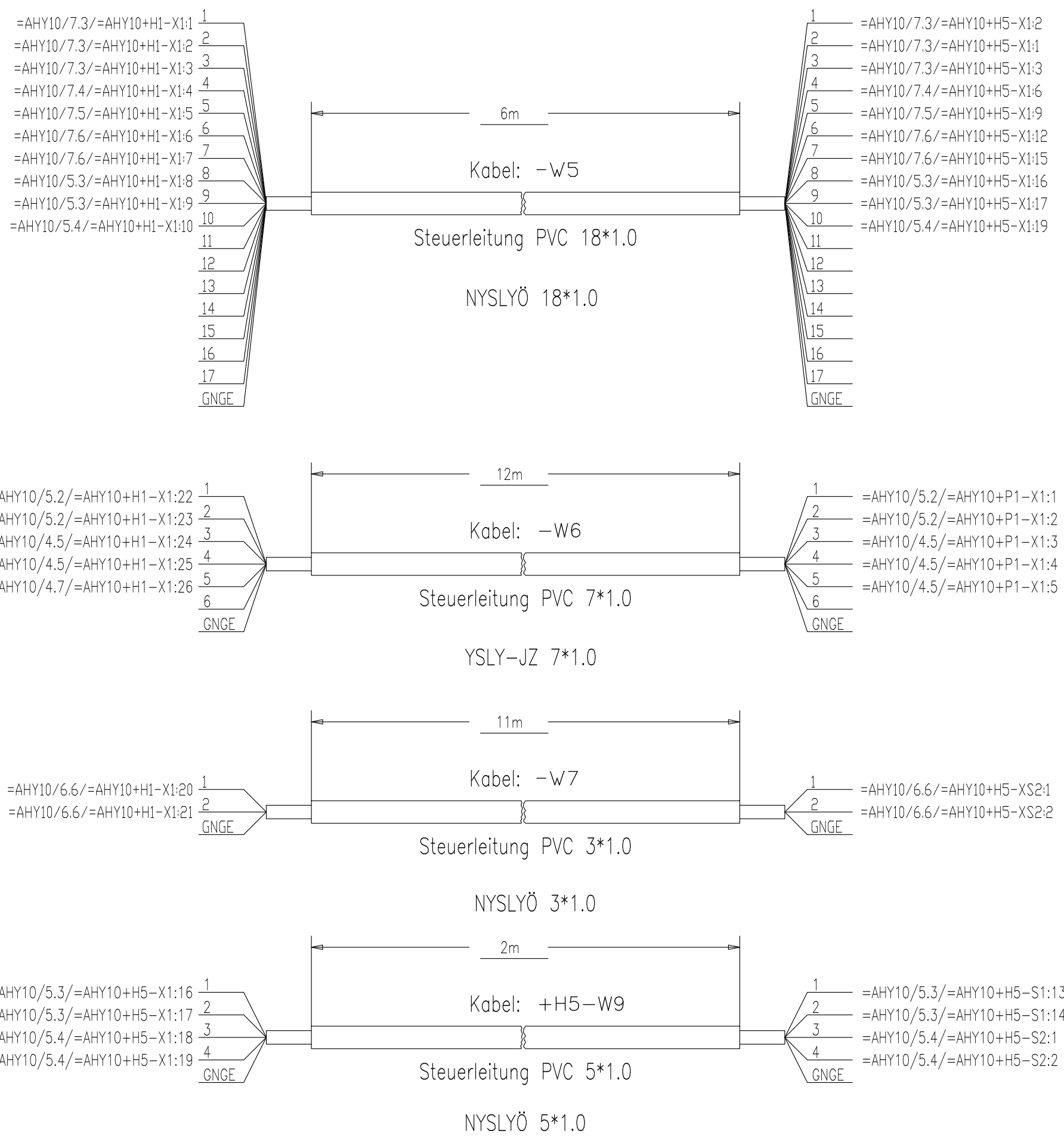

Datum	24.11.2017	Demoprojekt	TinLine GmbH Schüemattstrasse 4 CH - 5643 Sins	Kabelplan II	Zeichnungsnummer 40.8050-17	= AHY10	
Bearb.	TinLine					+ H1	
Gepr.						14 Bl.	Blatt 10
Rev.	Änderung	Datum	Name	Norm	23-4000.17		

1 2 3 4 5 6 7 8

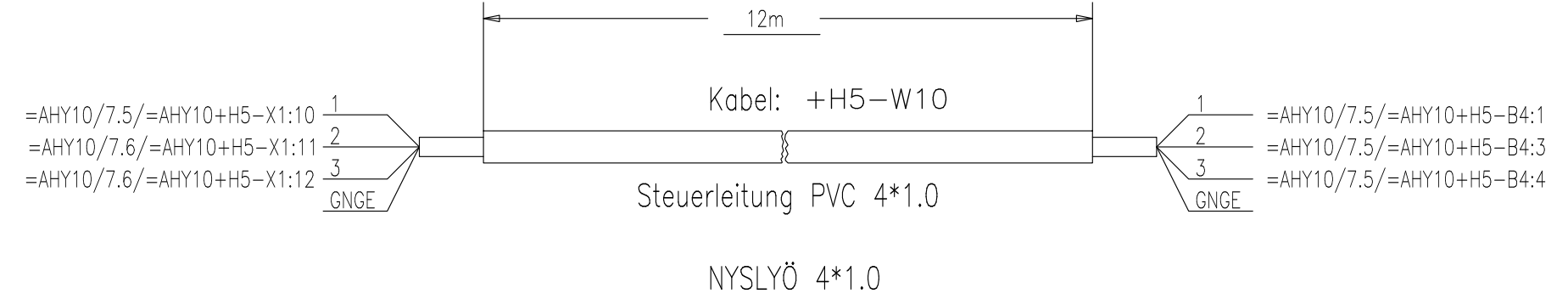
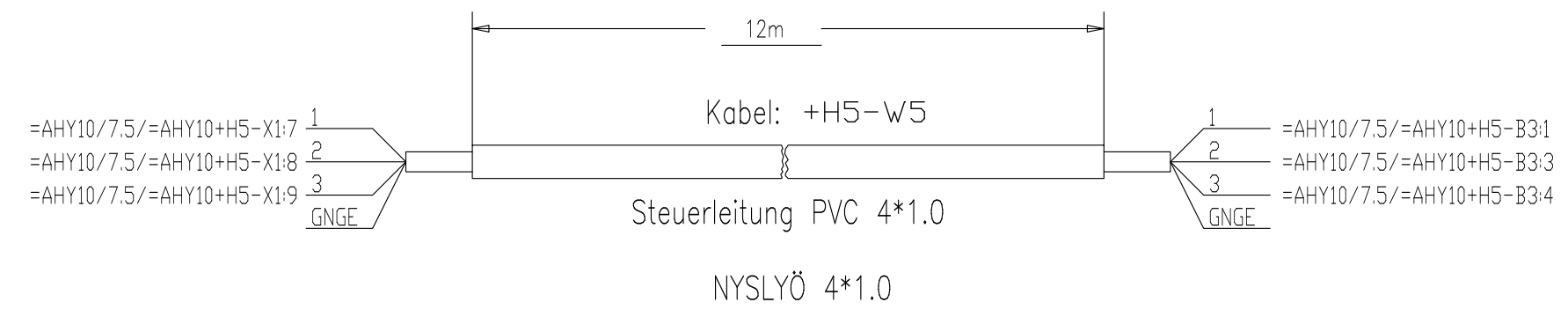
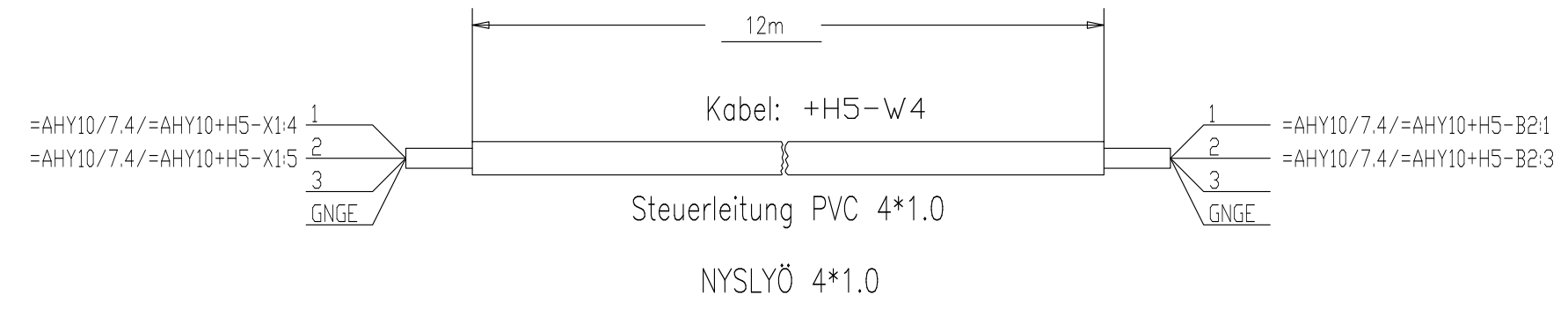
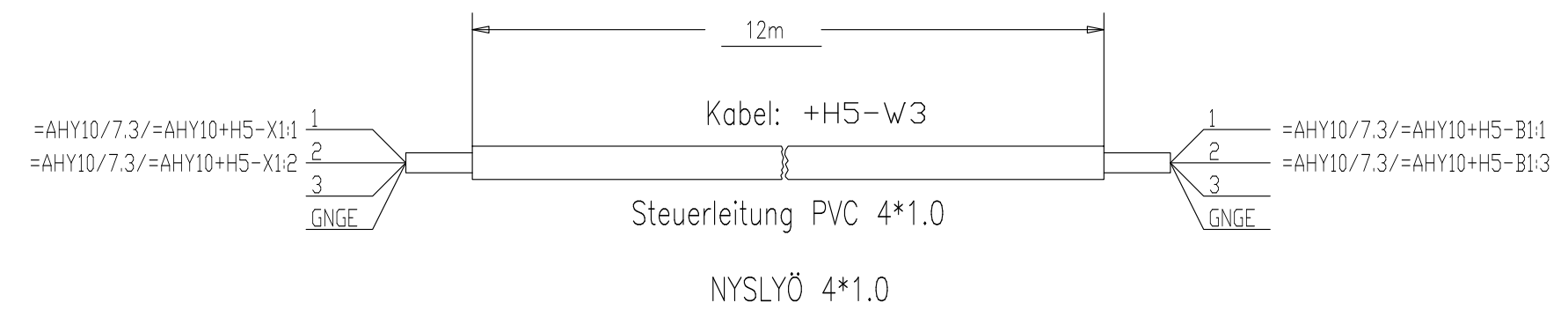
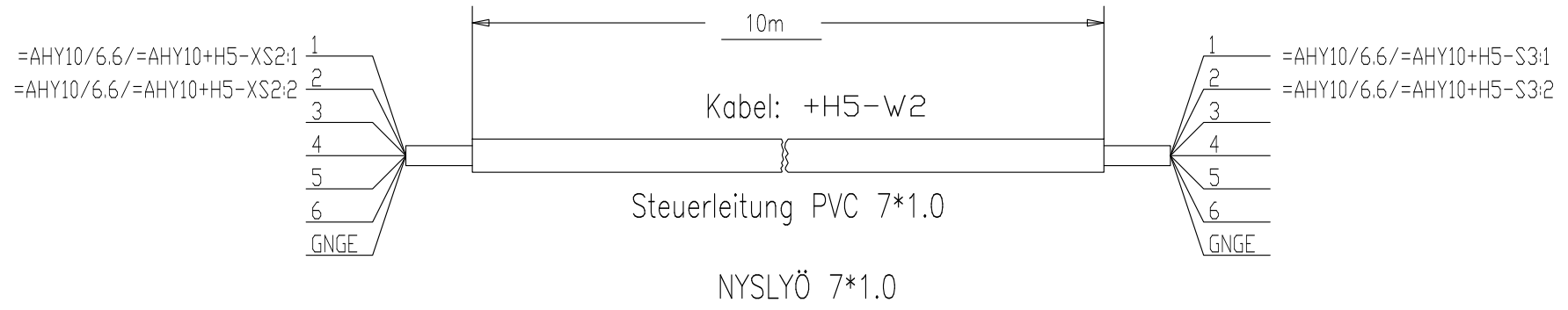

TinLine GmbH

Datum	24.11.2017	Demoprojekt	TinLine GmbH Schümattstrasse 4 CH - 5643 Sins	Kabelplan III	Zeichnungsnummer 40.8050-17	= AHY10	
Bearb.	TinLine					+ H1	
Gepr.						14 Bl.	Blatt 11
Rev.	Änderung	Datum	Name	Norm	23-4000.17		

< 10 1 2 3 4 5 6 7 8 12 >

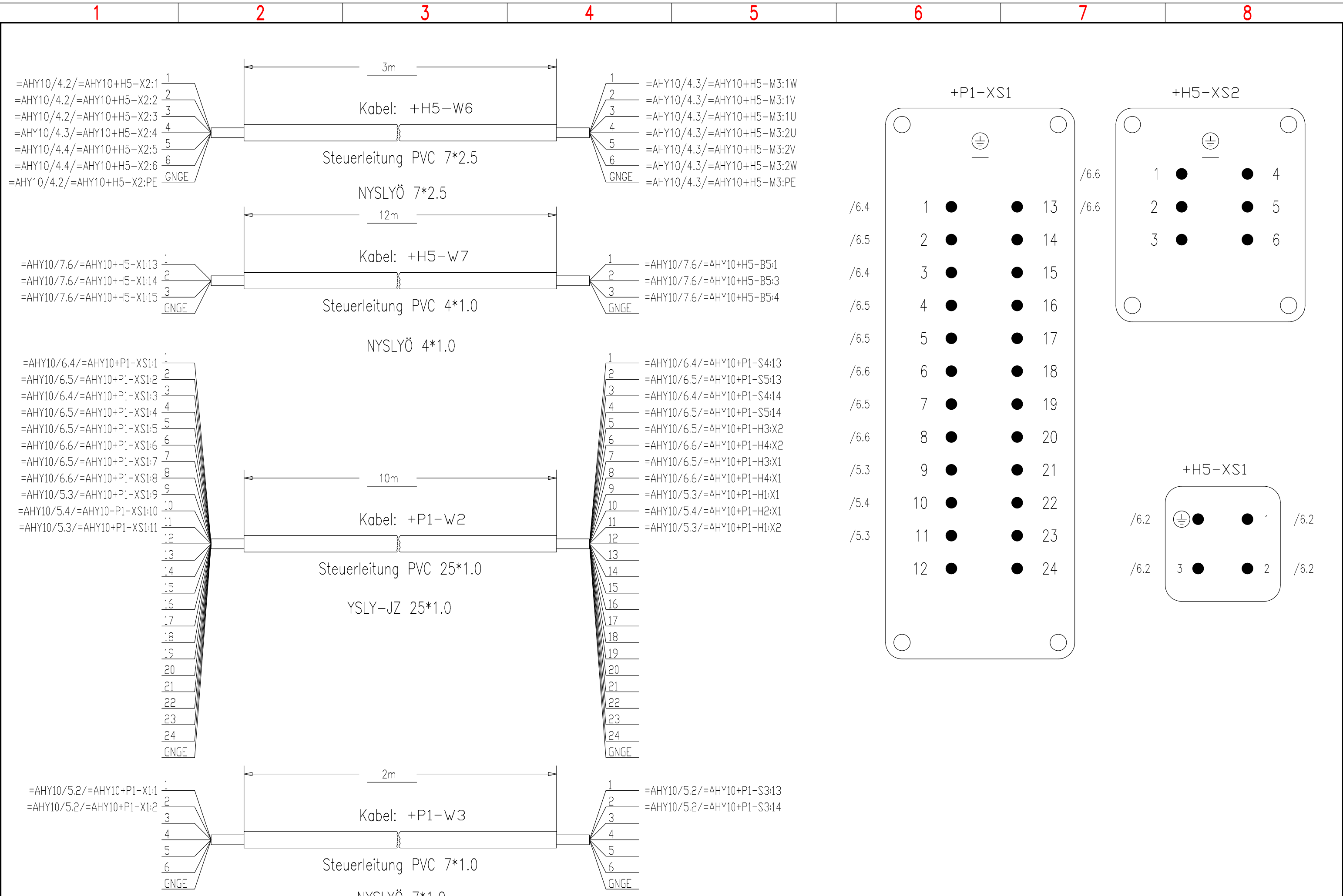

TinLine GmbH		Datum	24.11.2017	Demoprojekt	TinLine GmbH Schüemattstrasse 4 CH - 5643 Sins	Kabelplan IV Steckerplan	Zeichnungsnummer 40.8050-17	= AHY10	
Rev.	Änderung	Datum	Name					+ H1	
< 11	1	2	3	4	5	6	7	8	13 >
							14 Bl.	Blatt 12	

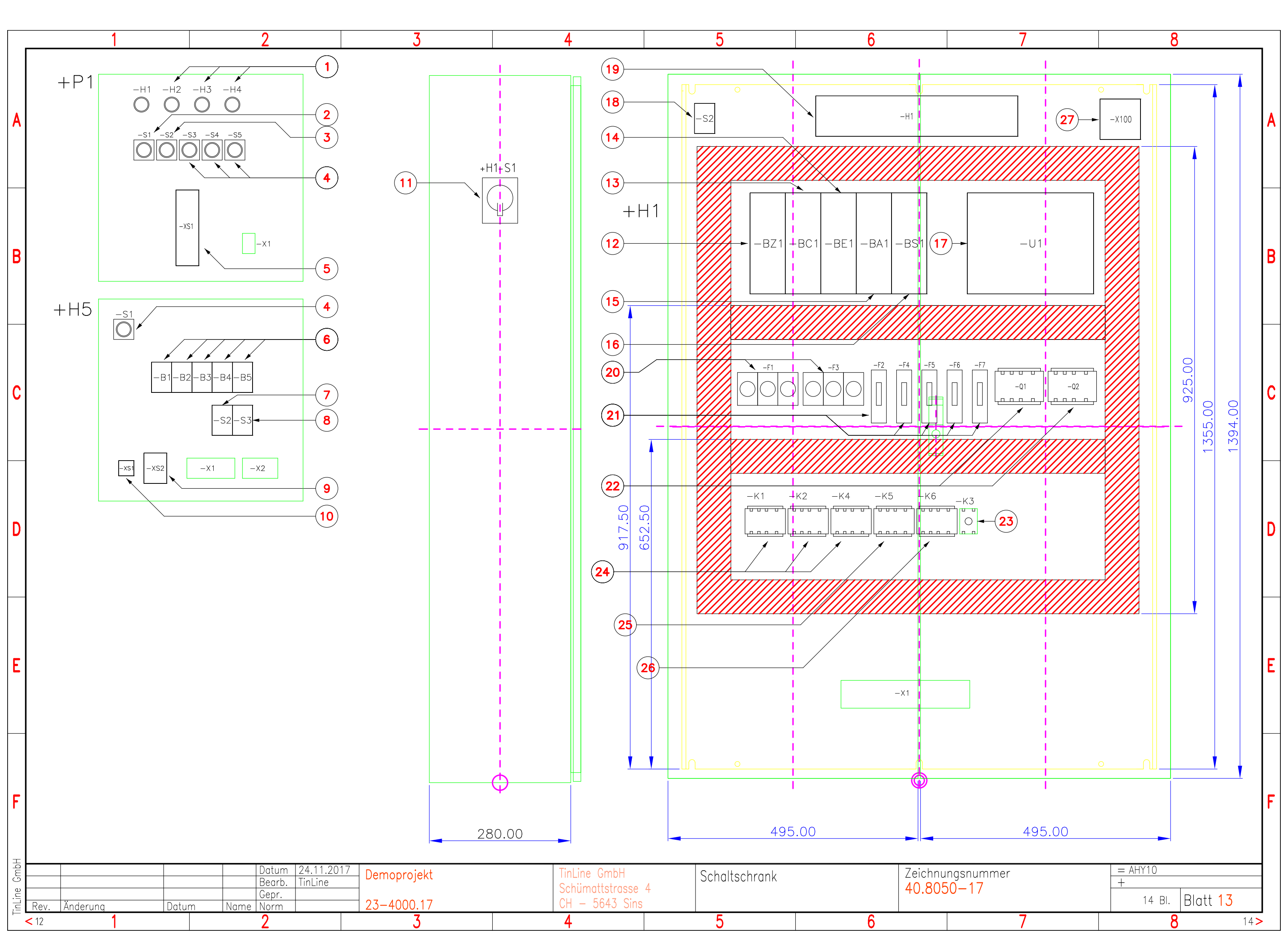

TinLine GmbH

Datum	24.11.2017
Bearb.	TinLine
Gepr.	
Norm	

Demoprojekt
23-4000.17

TinLine GmbH
Schüemattstrasse 4
CH - 5643 Sins

Schaltschrank

Zeichnungsnummer
40.8050-17

= AHY10	
+	
14 Bl.	Blatt 13

+H1

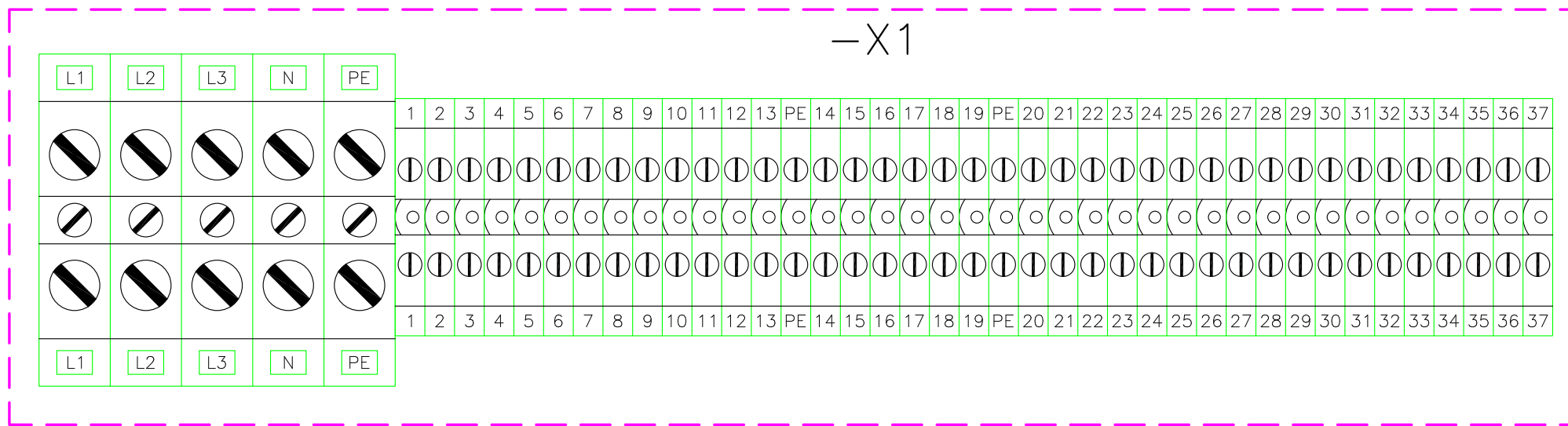

-X1

+H5

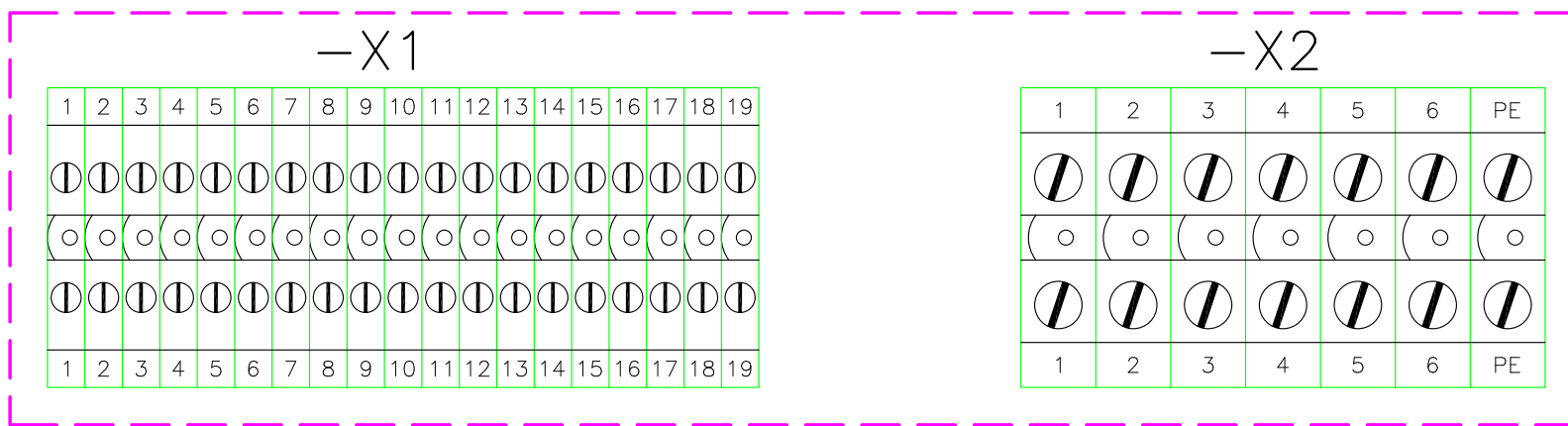

-X1

-X2

+P1

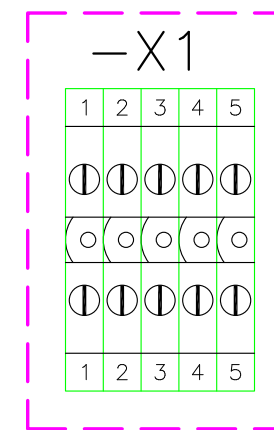

-X1

1		2		3		4		5		6		7		8			
Gerätebezeichnung Techn. Daten		Anlage	Einbau Ort	Geräte BMK	Schaltzeichen, Strompfad		Stromlaufplan										
A	100001 Schuetz 3TJ1004-0BB4,22																
		AHY10	H1	K5	5.2	6.8											
B	100011 Schuetz 3TJ1004-0BB4,H11																
		AHY10	H1	K6	6.4	6.2	4.5										
C	12511678 220V/50Hz, 10A, 2W																
		AHY10	H1	K3	4.7	4.5											
D	1271252 Motorschutzschalter 3VE1010-2H, I=1.6-2.5A																
		AHY10	H1	Q1	4.2	4.5	5.5										
E	1358550 Hauptschalter																
		AHY10	H1	Q2	6.2	6.7											
F	1358550 Hauptschalter																
		AHY10	H1	S1	3.1												



TinLine GmbH

Rev.		Änderung		Datum		Name		Datum		24.11.2017		TinLine		Demoprojekt		TinLine GmbH		Schümmattstrasse 4		CH - 5643 Sins		Graf. Betriebsmittelliste		EVU		Zeichnungsnummer		40.8050-17		= GSLIST		+		4 Bl.		Blatt 1	
------	--	----------	--	-------	--	------	--	-------	--	------------	--	---------	--	-------------	--	--------------	--	--------------------	--	----------------	--	---------------------------	--	-----	--	------------------	--	------------	--	----------	--	---	--	-------	--	---------	--

1	2		3	4	5	6	7	8
Geraetebezeichnung Techn. Daten	Anlage	Einbau Ort	Geraete BMK	Schaltzeichen, Strompfad Stromlaufplan				
A 200030 Drucktaster								
	AHY10	H5	S1	5.3				
	AHY10	P1	S3	5.2				
	AHY10	P1	S4	6.4				
B 5434502 Motor	AHY10	P1	S5	6.5				
C 600002 Schuetz 3TJ4219-OAM0,H2S20	AHY10	H5	M4	6.2				
	AHY10	H1	K1	4.5	4.3	4.7	4.6	
	AHY10	H1	K2	4.6	4.3	4.6	4.5	4.7
D 763243 Kontrolleuchte	AHY10	H1	K4	4.7	4.2	4.6		4.7
	AHY10	P1	H1	5.3				
E F	AHY10	P1	H2	5.4				
	AHY10	P1	H3	6.5				
	AHY10	P1	H4	6.6				

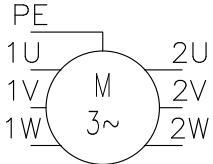
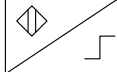

TinLine GmbH

Datum	24.11.2017	Demoprojekt	TinLine GmbH Schüemattstrasse 4 CH - 5643 Sins	Graf. Betriebsmittelliste EVU	Zeichnungsnummer 40.8050-17	= GSLIST +
Bearb.	TinLine					
Rev.	Änderung	Datum	Name	23-4000.17		4 Bl. Blatt 2

1		2		3		4		5		6		7		8		
Gerätebezeichnung Techn. Daten		Anlage		Einbau Ort		Geräte BMK		Schaltzeichen, Strompfad Stromlaufplan								
A	7730020 Gleichrichter															
			AHY10		H1		U1		3.7							
B	8768 Motor															
			AHY10		H5		M3		4.3							
C	883822 Initiator															
			AHY10		H5		B1		7.3							
D			AHY10		H5		B2		7.4							
			AHY10		H5		B3		7.5							
			AHY10		H5		B4		7.5							
			AHY10		H5		B5		7.6							
			AHY10		H5		B5		7.6							
E	F100 Hauptsicherung															
			AHY10		H1		F1		3.3							
			AHY10		H1		F3		3.7							
F																

TinLine GmbH

Rev.		Änderung		Datum		Name		Datum		24.11.2017		TinLine		Demoprojekt		TinLine GmbH		Schümattstrasse 4		CH - 5643 Sins		Graf. Betriebsmittelliste		EVU		Zeichnungsnummer		40.8050-17		= GSLIST		+		4 Bl.		Blatt 3	
23-4000.17																																					

1		2		3		4		5		6		7		8								
Gerätebezeichnung Techn. Daten		Anlage		Einbau Ort		Geräte BMK		Schaltzeichen, Strompfad		Stromlaufplan												
A	F102 Sicherungsautomat																					
																	AHY10	H1	F2	3.4		
																	AHY10	H1	F4	4.5		
																	AHY10	H1	F5	5.2		
																	AHY10	H1	F6	6.4		
B																						
																	AHY10	H1	F7	7.3		
C	S103 Drucktaster																					
																	AHY10	P1	S2	4.5		
D																						
E																						
F																						

						-W5	NYSLYÖ 18*1.0	6m			
						Nr. Typ	Querschnitt Kabel	Länge			
						Aderbezeichnung					
						X			2		
						X			1		
						X			3		
						X			4		
						X			5		
						X			6		
						X			7		
						X			8		
						X			9		
						X			10		

Klemmleiste =AHY10+H5-X1

Ziel intern =Anlage+Ort-BMK:Anschl	Querverweis	Brücke	Zusatz	Klemmen-Nr.	Ziel extern
					=Anlage+Ort-BMK:Anschl
2-X1+H1:	7.3	•		1	1-B1:
1-X1+H1:	7.3	•		2	3-B1:
3-X1+H1:	7.3	•		3	4-B1:
	7.4	•		4	1-B2:
	7.4	•	⚡	5	3-B2:
4-X1+H1:	7.4	•		6	4-B2:
	7.5	•		7	1-B3:
	7.5	•		8	3-B3:
5-X1+H1:	7.5	•	⚡	9	4-B3:
	7.5	•		10	1-B4:
	7.6	•		11	3-B4:
6-X1+H1:	7.6	•	⚡	12	4-B4:
	7.6	•		13	1-B5:
	7.6	•		14	3-B5:
7-X1+H1:	7.6	•	⚡	15	4-B5:
8-X1+H1:	5.3	•		16	13-S1:
9-X1+H1:	5.3	•		17	14-S1:
	5.4	•		18	1-S2:
10-X1+H1:	5.4			19	2-S2:

Aderbezeichnung	Nr. Typ	Querschnitt Kabel	Länge																				
				-W3	NYSLYÖ 4*1.0	12m	-W4	NYSLYÖ 4*1.0	12m	-W5	NYSLYÖ 4*1.0	12m	-W10	NYSLYÖ 4*1.0	12m	-W7	NYSLYÖ 4*1.0	12m	-W9	NYSLYÖ 5*1.0	2m		
1				X																			
2				X																			
1					X																		
2					X																		
1						X																	
2						X																	
3						X																	
1							X																
2							X																
3							X																
1								X															
2								X															
3								X															
1									X														
2									X														
3									X														
4										X													

Bemerkung

A

B

C

D

E

F

A

B

C

D

E

F

A

B

C

D

E

F

A

B

C

D

E

F

										14m	Länge
										NYSLYÖ 7*2.5	Querschnitt
										-W1	Kabel
										Nr. Typ	Aderbezeichnung
										X	1
										X	2
										X	3
										X	4
										X	5
										X	6
										X	GNGE

Klemmleiste =AHY10+H5-X2

Ziel intern	Querverweis	Brücke	Zusatz	Klemmen-Nr.	Ziel extern
=Anlage+Ort-BMK:Anschl					=Anlage+Ort-BMK:Anschl
11-X1+H1:	4.2			1	1W-M3:
12-X1+H1:	4.2			2	1V-M3:
13-X1+H1:	4.2			3	1U-M3:
14-X1+H1:	4.3			4	2U-M3:
15-X1+H1:	4.4			5	2V-M3:
16-X1+H1:	4.4			6	2W-M3:
PE-X1+H1:	4.2			PE	PE-M3:

										3m	Länge
										NYSLYÖ 7*2.5	Querschnitt
										-W6	Kabel
										Nr. Typ	Aderbezeichnung
										X	1
										X	2
										X	3
										X	4
										X	5
										X	6
										X	GNGE

Bemerkung

HYDRAULIK
 ”
 ”
 ”
 ”
 ”
 ”

A

B

C

D

E

F

A

B

C

D

E

F

										-W3	YSL1TYF-JZ	PUR-F	4*2.5	8m	Länge	Aderbezeichnung
										Nr.	Typ	Querschnitt	Kabel			
											X					1
											X					2
											X					3
											X					GNGE

Klemmleiste =AHY10+H5-XS1

Ziel intern	Querverweis	Brücke	Zusatz	Klemmen-Nr.	Ziel extern
=Anlage+Ort-BMK:Anschl					=Anlage+Ort-BMK:Anschl
17-X1+H1:	6.2			1	U-M4:
18-X1+H1:	6.2			2	V-M4:
19-X1+H1:	6.2			3	W-M4:
PE-X1+H1:	6.2			PE	PE-M4:

Aderbezeichnung	Nr.	Typ	Querschnitt	Kabel	Länge

Bemerkung

PUMPE
"
"
"

A
B
C
D
E
F

A
B
C
D
E
F

										Nr. Typ	Querschnitt Kabel	Länge	Aderbezeichnung	
											-W7	NYSLVÖ 3*1.0	11m	
											X			1
											X			2

Klemmleiste =AHY10+H5-XS2

Ziel intern	Querverweis	Brücke	Zusatz	Klemmen-Nr.	Ziel extern
=Anlage+Ort-BMK:Anschl					=Anlage+Ort-BMK:Anschl
20-X1+H1:	6.6			1	1-S3:
21-X1+H1:	6.6			2	2-S3:
	.			3	
	.			4	
	.			5	
	.			6	
	.			PE	

										Nr. Typ	Querschnitt Kabel	Länge	Aderbezeichnung	
											-W2	NYSLVÖ 7*1.0	10m	
											X			1
											X			2

Bemerkung

A

B

C

D

E

F

A

B

C

D

E

F

-W6	YSLY-JZ 7*1.0	12m																				
-W3	NYSLYØ 7*1.0	2m																				
Nr. Typ	Querschnitt	Länge	Aderbezeichnung																			
			Kabel																			

Klemmleiste =AHY10+P1-X1

Ziel intern					Ziel extern
=Anlage+Ort-BMK:Anschl	Querverweis	Brücke	Zusatz	Klemmen-Nr.	=Anlage+Ort-BMK:Anschl
13-S3:	5.2			1	22-X1+H1:
23-X1+H1:	5.2			2	14-S3:
11-S1:	4.5			3	24-X1+H1:
14-S2:	4.5			4	25-X1+H1:
12-S1:	4.5			5	26-X1+H1:

Nr. Typ	Querschnitt	Länge	Aderbezeichnung																			
			Kabel																			

Bemerkung

A

B

C

D

E

F

A

B

C

D

E

F

										YSL11YF-JZ PUR-F 18*1.0 6m		
										Nr. Typ	Querschnitt Kabel	Länge
										Aderbezeichnung		
										X		1
										X		2
										X		3
										X		4
										X		5
										X		6
										X		7
										X		8
										X		9
										X		10
										X		11

Klemmleiste =AHY10+P1-XS1

=Anlage+Ort-BMK:Anschl	Ziel intern	Querverweis	Brücke	Zusatz	Klemmen-Nr.	Ziel extern	=Anlage+Ort-BMK:Anschl
27-X1+H1:		6.4			1	13-S4:	
28-X1+H1:		6.5			2	13-S5:	
29-X1+H1:		6.4			3	14-S4:	
30-X1+H1:		6.5			4	14-S5:	
31-X1+H1:		6.5			5	X2-H3:	
32-X1+H1:		6.6			6	X2-H4:	
33-X1+H1:		6.5			7	X1-H3:	
34-X1+H1:		6.6			8	X1-H4:	
35-X1+H1:		5.3			9	X1-H1:	
36-X1+H1:		5.4			10	X1-H2:	
37-X1+H1:		5.3			11	X2-H1:	
		5.3				X2-H2:	
		.			12		
		.			13		
		.			14		
		.			15		
		.			16		
		.			17		
		.			18		
		.			19		
		.			20		
		.			21		
		.			22		
		.			23		
		.			24		
		.			PE		

										YSL1-JZ 25*1.0 10m		
										Nr. Typ	Querschnitt Kabel	Länge
										Aderbezeichnung		
										X		1
										X		2
										X		3
										X		4
										X		5
										X		6
										X		7
										X		8
										X		9
										X		10
										X		11
										X		11

Bemerkung

Bauteilliste

Nr.	Anlage	BMK	Ort	Artikelnummer	Beschreibung	Bestellnummer	Hersteller	Seite
1	AHY10	BA1	H1	9898933	SPS-Ausgabebaugruppe	6ES5 451-8MA11	Siemens	8.6
2	AHY10	BC1	H1	8783838	SPS, CPU	S5 100U-CPU100	Siemens	8.3
3	AHY10	BE1	H1	8977777	SPS-Baugruppe 16E	6ES5 422-8MA11	Siemens	8.5
4	AHY10	BS1	H1	9097666	SPS-Simu-Baugruppe	6ES5 788-8MA11	Siemens	8.7
5	AHY10	BZ1	H1	9984949	SPS-Stromversorgung	6ES5 980-3BC61	Siemens	8.2
6	AHY10	F1	H1	F100	Hauptsicherung	112109	AEG	3.3
7	AHY10	F2	H1	F102	Sicherungsautomat	S221-K6	AEG	3.4
8	AHY10	F3	H1	F100	Hauptsicherung	112109	AEG	3.7
9	AHY10	F4	H1	F102	Sicherungsautomat	S221-K6	AEG	4.5
10	AHY10	F5	H1	F102	Sicherungsautomat	S221-K6	AEG	5.2
11	AHY10	F6	H1	F102	Sicherungsautomat	S221-K6	AEG	6.4
12	AHY10	F7	H1	F102	Sicherungsautomat	S221-K6	AEG	7.3
13	AHY10	H1	H1	655577	Leuchstofflampe	79888348	Philips	3.4
14	AHY10	K1	H1	600002	Schuetz	07815S	Siemens	4.5
15	AHY10	K2	H1	600002	Schuetz	07815S	Siemens	4.6
16	AHY10	K3	H1	12511678	Zeitrelais	87AW2222W	Haller	4.7
17	AHY10	K4	H1	600002	Schuetz	07815S	Siemens	4.7
18	AHY10	K5	H1	1000001	Schuetz	67565476	K-M	5.2
19	AHY10	K6	H1	1000011	Schuetz	44555	K-M	6.4
20	AHY10	Q1	H1	1271252	Motorschutzschalter	04198	Siemens	4.2
21	AHY10	Q2	H1	1271252	Motorschutzschalter	04198	Siemens	6.2
22	AHY10	S1	H1	1358550	Hauptschalter	C10-16E	Kraus&Naimer	3.1
23	AHY10	S2	H1	1501522	Endschalter	14345656	Rafi	3.4
24	AHY10	U1	H1	7730020	Gleichrichter	78778-00.11	Germann	3.7
25	AHY10	W1	H1	30073	Kabel YSL11YF 7*2.5	30073	Lapp	4.2
26	AHY10	W3	H1	30066	Kabel YSL11YF 4*2.5	30066	Lapp	6.2
27	AHY10	W4	H1	30076	Kabel YSL11YF 18*1.0	30076	Lapp	6.4
28	AHY10	W5	H1	30195	Kabel NYSLYÖ 18*1.0	30195	Lapp	7.3
29	AHY10	W6	H1	30187	Kabel NYSLYÖ 7*1.0	30187	Lapp	5.2
30	AHY10	W7	H1	30175	Kabel NYSLYÖ 3*1.0	30175	Lapp	6.6
31	AHY10	X100	H1	54468	Steckdose	98080439	Siemens	3.5
32	AHY10	B1	H5	883822	Initiator	7873828	AEG	7.3
33	AHY10	B2	H5	883822	Initiator	7873828	AEG	7.4
34	AHY10	B3	H5	883822	Initiator	7873828	AEG	7.5
35	AHY10	B4	H5	883822	Initiator	7873828	AEG	7.5
36	AHY10	B5	H5	883822	Initiator	7873828	AEG	7.6
37	AHY10	M3	H5	8768	Motor	4879843759	Siemens	4.3
38	AHY10	M4	H5	5434502	Motor	87987	Siemens	6.2
39	AHY10	S1	H5	200030	Drucktaster	51-151.022	Lumitas	5.3

Datum	24.11.2017	Demoprojekt	TinLine GmbH Schüemattstrasse 4 CH - 5643 Sins	Bauteilliste	Zeichnungsnummer 40.8050-17	= LISTEN +
Bearb.	TinLine					
Gepr.						
Rev.	Änderung	Datum	Name	23-4000.17	5 Bl.	Blatt 10

Bauteilliste

Nr.	Anlage	BMK	Ort	Artikelnummer	Beschreibung	Bestellnummer	Hersteller	Seite
40	AHY10	S2	H5	150111	Druckabh. Schalter	1444446	Rafi	5.4
41	AHY10	S3	H5	7783273	Temp.Schalter	89494949	Rafi	6.6
42	AHY10	W2	H5	30187	Kabel NYSLYÖ 7*1.0	30187	Lapp	6.6
43	AHY10	W3	H5	30179	Kabel NYSLYÖ 4*1.0	30179	Lapp	7.3
44	AHY10	W4	H5	30179	Kabel NYSLYÖ 4*1.0	30179	Lapp	7.4
45	AHY10	W5	H5	30179	Kabel NYSLYÖ 4*1.0	30179	Lapp	7.5
46	AHY10	W6	H5	30189	Kabel NYSLYÖ 7*2.5	30189	Lapp	4.2
47	AHY10	W7	H5	30179	Kabel NYSLYÖ 4*1.0	30179	Lapp	7.6
48	AHY10	W9	H5	30183	Kabel NYSLYÖ 5*1.0	30183	Lapp	5.3
49	AHY10	W10	H5	30179	Kabel NYSLYÖ 4*1.0	30179	Lapp	7.5
50	AHY10	XS1	H5	457855	Stecker Han3A	122-45454	Harting	12.8
51	AHY10	XS2	H5	45789798	Stecker Han6E	122-4546	Harting	12.7
52	AHY10	H1	P1	763243	Kontrolleuchte	154	Rafi	5.3
53	AHY10	H2	P1	763243	Kontrolleuchte	154	Rafi	5.4
54	AHY10	H3	P1	763243	Kontrolleuchte	154	Rafi	6.5
55	AHY10	H4	P1	763243	Kontrolleuchte	154	Rafi	6.6
56	AHY10	S1	P1	1501500	Drucktaster	12125-5656	Rafi	4.5
57	AHY10	S2	P1	S103	Drucktaster	12125-5656	Rafi	4.5
58	AHY10	S3	P1	200030	Drucktaster	51-151.022	Lumitas	5.2
59	AHY10	S4	P1	200030	Drucktaster	51-151.022	Lumitas	6.4
60	AHY10	S5	P1	200030	Drucktaster	51-151.022	Lumitas	6.5
61	AHY10	W2	P1	30059	Kabel YSLY-JZ 25*1.0	30059	Lapp	6.4
62	AHY10	W3	P1	30187	Kabel NYSLYÖ 7*1.0	30187	Lapp	5.2
63	AHY10	XS1	P1	4578979	Stecker Han24E	122-4545	Harting	12.6

Kabelliste

Anlage	BMK	ORT	Kabeltyp	Bel.	Ziel von			Ziel nach		
					Anlage	Ort	BMK	Anlage	Ort	BMK
AHY10	W1	H1	NYSLYÖ 7*2.5	7	AHY10	H1	X1	AHY10	H5	X2
AHY10	W3	H1	YSL11YF-JZ PUR-F 4*2.5	4	AHY10	H1	X1	AHY10	H5	XS1
AHY10	W4	H1	YSL11YF-JZ PUR-F 18*1.0	11	AHY10	H1	X1	AHY10	P1	XS1
AHY10	W5	H1	NYSLYÖ 18*1.0	10	AHY10	H1	X1	AHY10	H5	X1
AHY10	W6	H1	YSLY-JZ 7*1.0	5	AHY10	H1	X1	AHY10	P1	X1
AHY10	W7	H1	NYSLYÖ 3*1.0	2	AHY10	H1	X1	AHY10	H5	XS2
AHY10	W2	H5	NYSLYÖ 7*1.0	2	AHY10	H5	XS2	AHY10	H5	S3
AHY10	W3	H5	NYSLYÖ 4*1.0	2	AHY10	H5	X1	AHY10	H5	B1
AHY10	W4	H5	NYSLYÖ 4*1.0	2	AHY10	H5	X1	AHY10	H5	B2
AHY10	W5	H5	NYSLYÖ 4*1.0	3	AHY10	H5	X1	AHY10	H5	B3
AHY10	W6	H5	NYSLYÖ 7*2.5	7	AHY10	H5	X2	AHY10	H5	M3
AHY10	W7	H5	NYSLYÖ 4*1.0	3	AHY10	H5	X1	AHY10	H5	B5
AHY10	W9	H5	NYSLYÖ 5*1.0	4	AHY10	H5	X1	AHY10	H5	S1
AHY10	W10	H5	NYSLYÖ 4*1.0	3	AHY10	H5	X1	AHY10	H5	B4
AHY10	W2	P1	YSLY-JZ 25*1.0	11	AHY10	P1	XS1	AHY10	P1	S4
AHY10	W3	P1	NYSLYÖ 7*1.0	2	AHY10	P1	X1	AHY10	P1	S3

Datum		24.11.2017	
Bearb.		TinLine	
Gepr.			
Norm			

Demoprojekt
23-4000.17

TinLine GmbH
Schümattstrasse 4
CH - 5643 Sins

Kabelliste

Zeichnungsnummer
40.8050-17

= LISTEN	
+	
5 Bl.	Blatt 50

SPS-Liste

Adresse	E/A Funktionstext	Seite	AP	BMK	Anlage	Ort
A0.0	Pumpe Freigabe	5	4	BA1	AHY10	H1
A0.1	Pumpe läuft	5	3	BA1	AHY10	H1
A0.2	Pumpe Störung	5	6	BA1	AHY10	H1
A0.3	Kühlmittel EIN	6	5	BA1	AHY10	H1
A0.4	Kühlmittel läuft	6	8	BA1	AHY10	H1
A0.5	Störung	6	7	BA1	AHY10	H1
A0.6				BA1	AHY10	H1
A0.7				BA1	AHY10	H1
E1.0	Lampentest	5	1	BE1	AHY10	H1
E1.1	Abdeckung geschlossen	5	2	BE1	AHY10	H1
E1.2	Öldruck OK	5	3	BE1	AHY10	H1
E1.3	Motorschutz-Antrieb	5	4	BE1	AHY10	H1
E1.4	Hydraulikpumpe EIN	5	5	BE1	AHY10	H1
E1.5	Kühlung AUS	6	6	BE1	AHY10	H1
E1.6	Kühlung EIN man.	6	7	BE1	AHY10	H1
E1.7	Kühlung EIN auto.	6	8	BE1	AHY10	H1
E2.0	Motorschutz-Kühlung	6	9	BE1	AHY10	H1
E2.1	Kühlung läuft	6	10	BE1	AHY10	H1
E2.2	Greifer oben	7	11	BE1	AHY10	H1
E2.3	Greifer unten	7	12	BE1	AHY10	H1
E2.4	Greifer mitte	7	13	BE1	AHY10	H1
E2.5	Greifer Gefahr	7	14	BE1	AHY10	H1
E2.6	Greifer läuft	7	15	BE1	AHY10	H1
E2.7				BE1	AHY10	H1

TinLine GmbH

Rev.	Änderung	Datum	Name	Datum	24.11.2017	Demoprojekt	TinLine GmbH Schüemattstrasse 4 CH - 5643 Sins	SPS-Liste	Zeichnungsnummer 40.8050-17	= LISTEN
					TinLine					+ 5 Bl. Blatt 70